

Jan.2018

STOCK CODE: 002449



**NATIONSTAR**  
—SINCE 1969—

# **LED LIGHTING**

## **Catalogue-Middle East**

### **Nationstar GmbH**

Kurfürstenstraße 10, 40211, Düsseldorf, Germany  
Tel: +49 (0) 211 91366663  
Fax: +49 (0) 211 91366661  
E-Mail: [jonny@nationstar.com](mailto:jonny@nationstar.com)

### **FOSHAN NATIONSTAR OPTOELECTRONICS CO.,LTD**

Add: No.18 South Huabao Road, Chancheng District, Foshan,Guangdong,P.R.China  
Tel: 0086-757-82100230 82109310  
Fax: 0086-757-82100200 P.C: 528000  
Web: [www.nationstar.com](http://www.nationstar.com) E-Mail: [jonny@nationstar.com](mailto:jonny@nationstar.com)

# 2018

NATIONSTAR, LIGHTING UP THE WORLD

# NATIONSTAR Worldwide





# Contents



Company Introduction ..... 02-03







## 01 OFFICE LIGHTING

	<b>LED Panel</b> Standard Version ..... 06
	<b>Pendant Linear</b> Pendant Linear ..... 07-08
	<b>LED Tube</b> LED Tube ..... 09

## 02 RETAIL LIGHTING

	<b>LED Track Light</b> LED Track Light ..... 11-12
	<b>LED Linear T5</b> LED Linear T5 ..... 13
	<b>LED Downlight</b> LED Downlight ..... 14-17

## 03 INDUSTRIAL LIGHTING

	<b>LED Batten IP65</b> LED Batten IP65 ..... 19-20
	<b>LED Flood Light</b> LED Flood Light ..... 21
	<b>High Bay Light</b> High Bay Light ..... 22
	<b>LED Street Light</b> LED Street Light ..... 22

## 04 DECORATIVE LIGHTING

	<b>LED Strip</b> IP20 Series ..... 24 IP65 Series ..... 25-26 Accessory ..... 27-28
---	--



01 MILESTONE

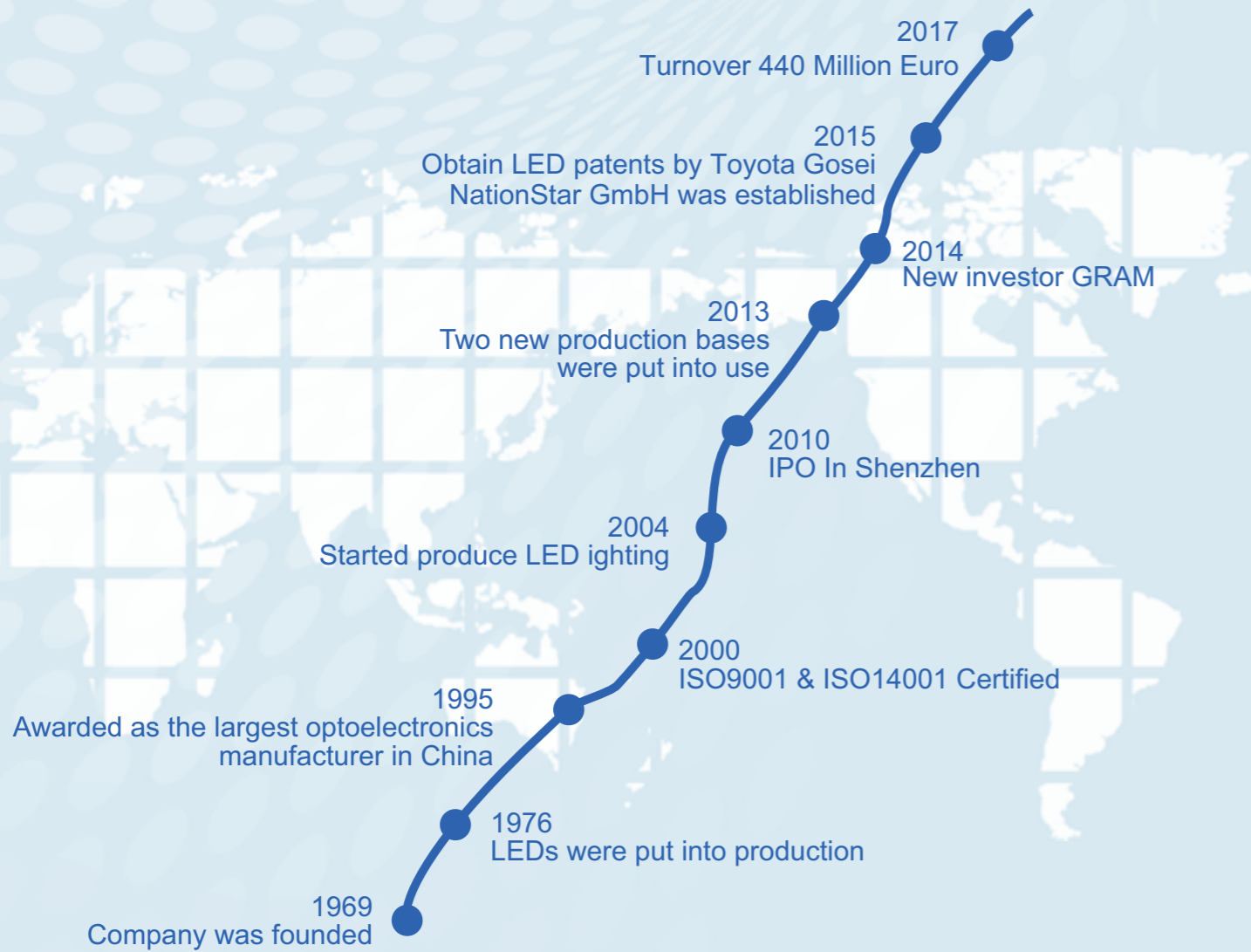

02 PRODUCTION CAPACITY

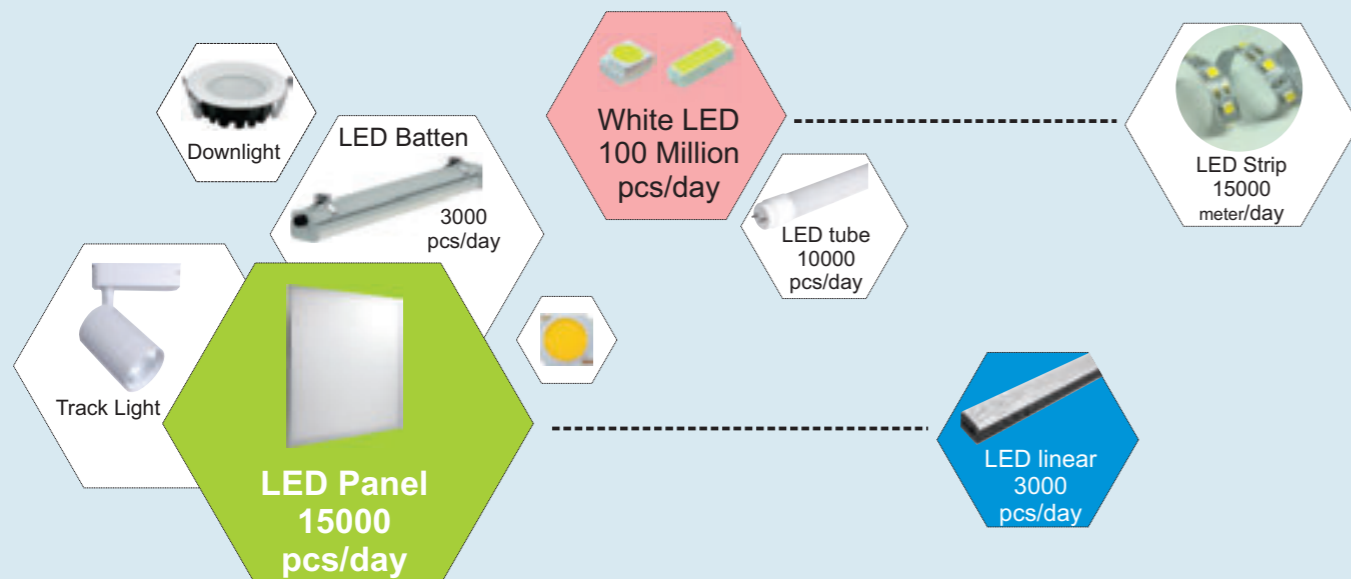

03 BRIEF INTRODUCTION

Foshan NationStar Optoelectronics Co.,Ltd has been specializing in LED industry for over 30 years, and started LED lighting manufacturing since 2004. With a strong R&D ability, reliable product quality and excellent after-sales service, NationStar becomes a leading manufacturer for chips, LEDs and LED lighting products.



The Northern Area of The Headquarter

Land area: 26,000 sqm.  
Plant for LED components and devices

The Southern Area of The Headquarter

Land area: 34,600 sqm.  
Production for LED and lighting products  
Production capacity of LEDs: 4,000KK per month



Foshan NationStar Semiconductor Co.,Ltd.

Land area: 32,000 sqm.  
The production base of GaN LED chips for lighting

04 INDUSTRIAL CHAIN



Chip



LED



Lighting





# Office Lighting

- AC230V
- 120°
- IP20
- No Flicker  
Optional
- 0-10V  
Optional
- DALI  
Optional
- Motion Sensor  
Available



## LED Panel Standard Version



### FEATURES

- Panel: 80-100 lm/W;
- Size: 60\*60, 30\*120cm;
- White frame, Flat surface, No gap on the corner;
- Option: UGR 19/22 available, Emergency kit;
- Driver: Flicker, Flicker Free, DALI, 0-10V.

40W 3600Lm Photometric

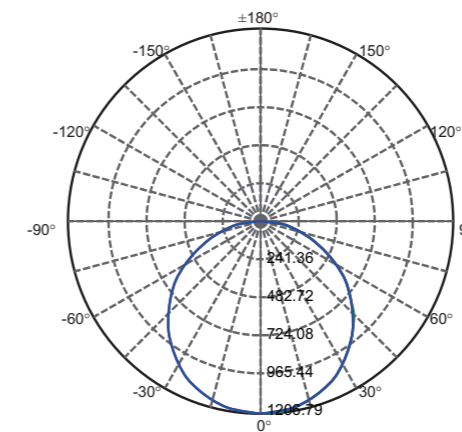

40W 3600Lm Luminance

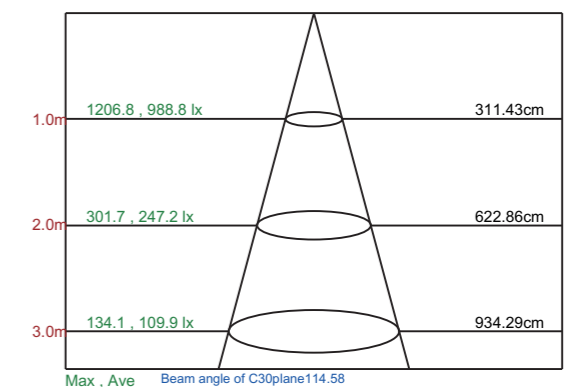

### TECHNICAL PARAMETERS

Series	Panel Rated Wattage(W) Included Driver	Dimension (mm)	Panel Input Current (mA)	Panel Input Wattage(W) Included Driver	**Efficiency (lm/W)	**Lumen (lm)	Standard CCT (K)	CRI (Ra)
NS-PLS-6060	36	595×595×7.2	900	32	80	2800	3000/4000/6500	>80
	40	595×595×7.5	1000	35	80	3200	3000/4000/6500	>80
	40	595×595×8.5	1000	35	100	4000	3000/4000/6500	>80
	50	595×595×7.5	1000	45	100	5000	3000/4000/6500	>80
NS-PLS-30120	40	295×1195×8.5	1000	35	80	3600	3000/4000/6500	>80

\*\* Efficiency: It's for panel system, included driver consumption.

\*\* Lumen&Wattage: Type value with +/-10% tolerance.



## Pendant Linear



### FEATURES

- Ultra bright SMD LED;
- Design of optical module lens to control light distribution various beam angles;
- Built-in efficient constant current driver power supply;
- Replacement for the traditional tube linear light;
- Application: office, school.

36W 3600Lm Photometric

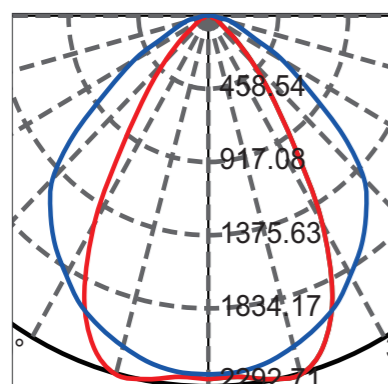

36W 3600Lm Luminance

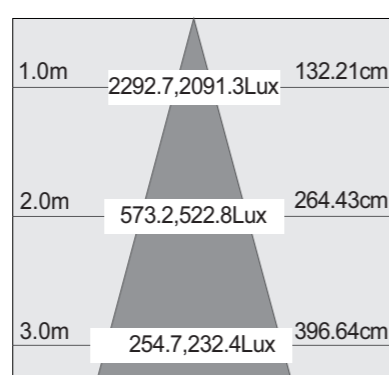

### DIMENSIONS

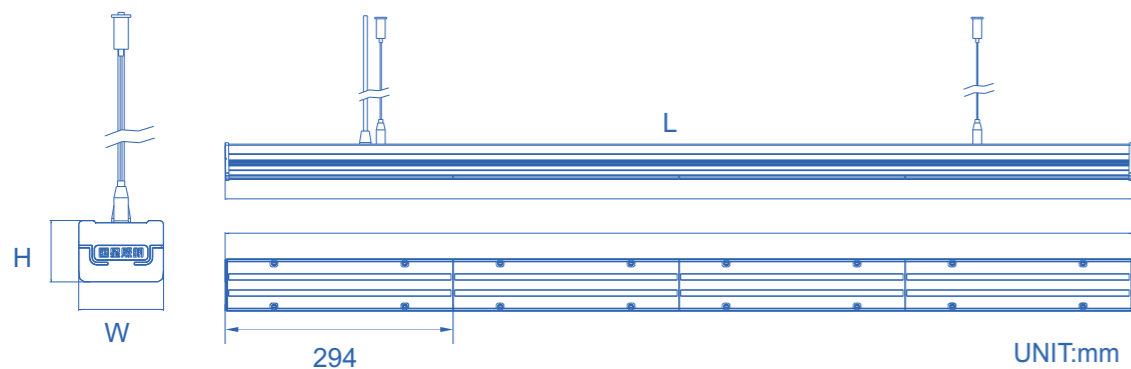

### TECHNICAL PARAMETERS

Series	Order number	Dimension(mm)	Wattage(W)	Lumen (Lm)	CRI (Ra)	CCT(K)	Angle/ (°)
NS-XCD-4	XCD4B36	L1180×W68×H49	36W	3600Lm	> 80	3000/4000/6500	60°
NS-XCD-5	XCD5B45	L1475×W68×H70	45W	4500Lm	> 80	3000/4000/6500	60°

\*\* Lumen&Wattage: Type value with +/-10% tolerance.



## Pendant Linear



### FEATURES

- Ultra bright SMD LED;
- Design of optical module lens to control light distribution various beam angles;
- Built-in efficient constant current driver power supply;
- Replacement for the traditional tube linear light;
- Application: office, school.

36W 3600Lm Photometric

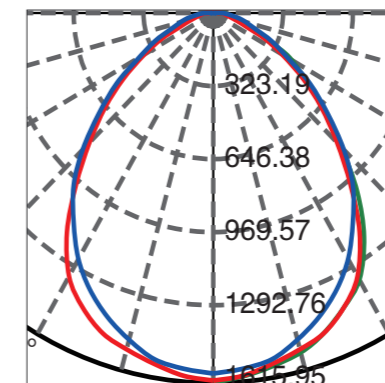

36W 3600Lm Luminance

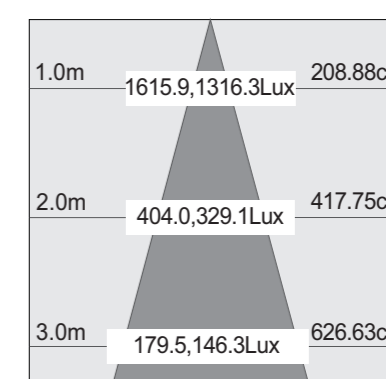

### DIMENSIONS

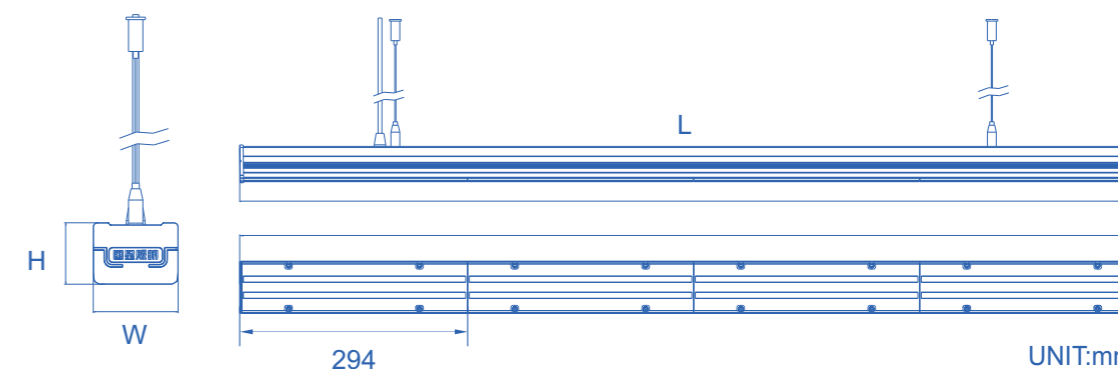

### TECHNICAL PARAMETERS

Series	Order number	Dimension(mm)	Wattage(W)	Lumen (Lm)	CRI (Ra)	CCT(K)	Angle/ (°)
NS-XCD-4	XCD4B36	L1180×W68×H49	36W	3600Lm	> 80	3000/4000/6500	90°
NS-XCD-5	XCD5B45	L1475×W68×H70	45W	4500Lm	> 80	3000/4000/6500	90°

\*\* Lumen&Wattage: Type value with +/-10% tolerance.

# LED Tube

## T8 Glass

### DIMENSIONS

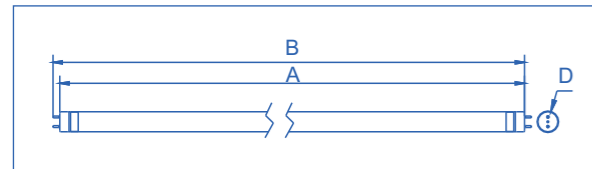

Length	A		B		D
	Max	Min	Max	Max	
0.6m	589.8	594.5	596.9	596.9	Ø26
0.9m	894.6	899.5	901.5	901.5	Ø26
1.2m	1199	1204.5	1206.5	1206.5	Ø26

---

### TECHNICAL PARAMETERS

Lumen&Wattage: Type value with +/-10% tolerance.  
Lamps must be approved for use in "open " luminaries.





## LED Track Light



### FEATURES

- Ultra bright COB LED;
- Combining recycled die-cast aluminium and extruded aluminium with polyester powder coating, resistant to acid and alkali, anti-oxidation, with good heat dissipation;
- Reflector made of high-class imported anodized aluminium, reflection rate up 85%;
- Option of beam angle 15°/24°/40°.

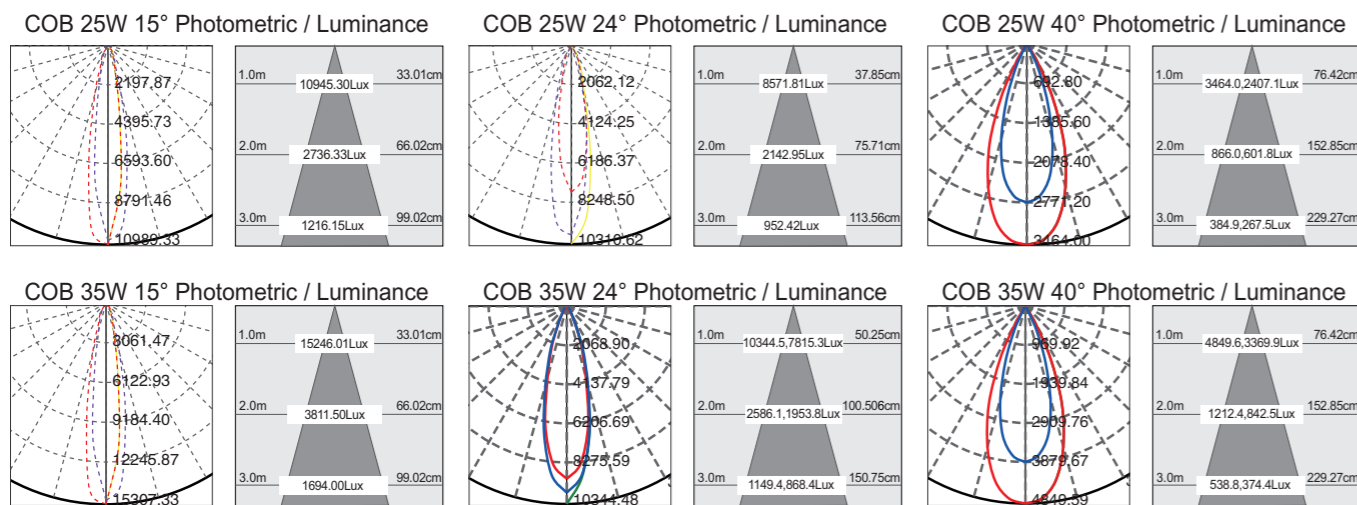

### DIMENSIONS

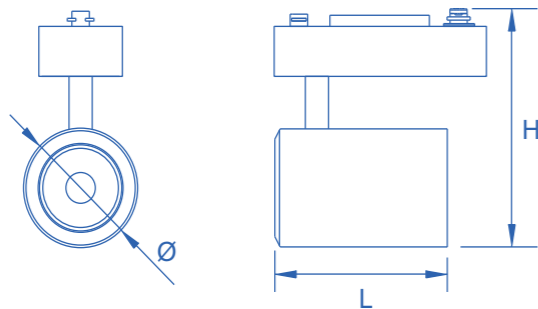

UNIT:mm

### TECHNICAL PARAMETERS

Order number	Wattage(W)	Dimension(mm)	Lumen (Lm)	CCT(K)	CRI (Ra)	Angle/ (°)	Installation
NS-GDD1-D25C	25W	L138×Φ76×H160	1750Lm	3000/4000/6500	> 90	15°/24°/40°	3PINS TRACK
NS-GDD1-D30C	30W	L140×Φ86×H160	2100Lm	3000/4000/6500	> 90	15°/24°/40°	3PINS TRACK
NS-GDD1-D35C	35W	L140×Φ86×H160	2500Lm	3000/4000/6500	> 90	15°/24°/40°	3PINS TRACK

\*\* Lumen&Wattage: Type value with +/-10% tolerance.



## LED Track Light



### FEATURES

- Ultra bright COB LED;
- Combining recycled die-cast aluminium and extruded aluminium with polyester powder coating, resistant to acid and alkali, anti-oxidation, with good heat dissipation;
- Reflector made of high-class imported anodized aluminium, reflection rate up 85%;
- Option of beam angle 15°/24°/40°.

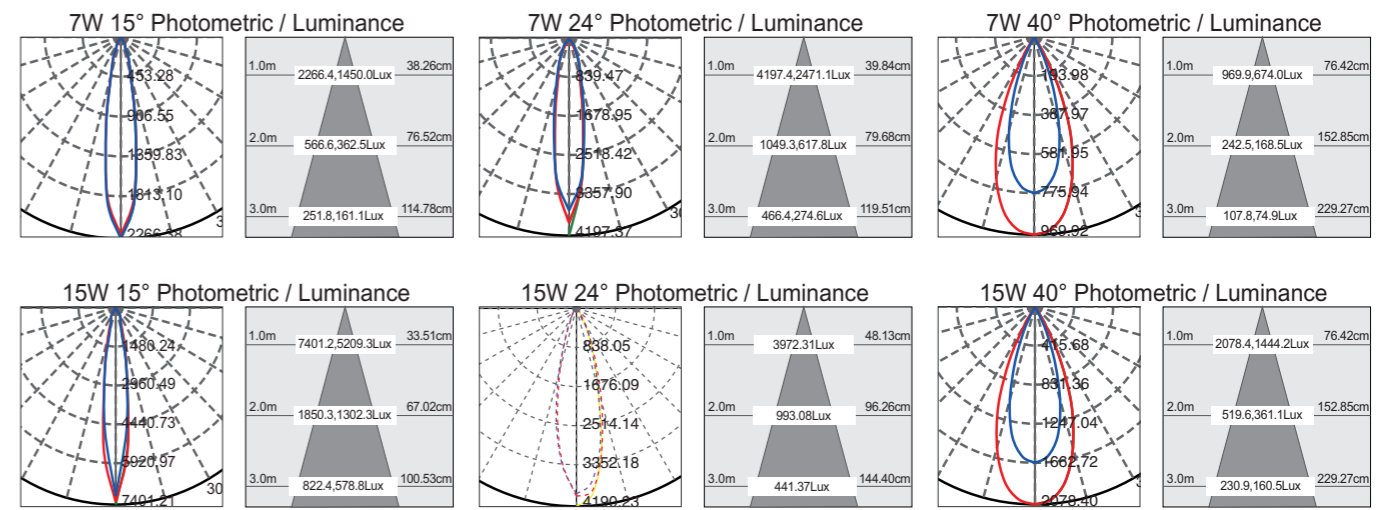

### DIMENSIONS

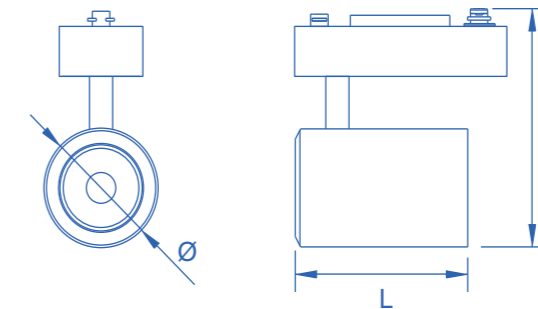

UNIT:mm

### TECHNICAL PARAMETERS

Order number	Wattage(W)	Dimension(mm)	Lumen (Lm)	CCT(K)	CRI (Ra)	Angle/ (°)	Installation
NS-GDD1-D7C	7W	L96×Φ56×H140	490Lm	3000/4000/6500	> 90	15°/24°/40°	3/4 PINS TRACK
NS-GDD1-D15C	15W	L118×Φ76×H148	1050Lm	3000/4000/6500	> 90	15°/24°/40°	3/4 PINS TRACK

\*\* Lumen&Wattage: Type value with +/-10% tolerance.



## LED Batten T5



### FEATURES

- Ultra bright SMD LED as light source;
- Can be connected with each other with connectors;
- All-plastic holder.

### DIMENSIONS

UNIT:mm

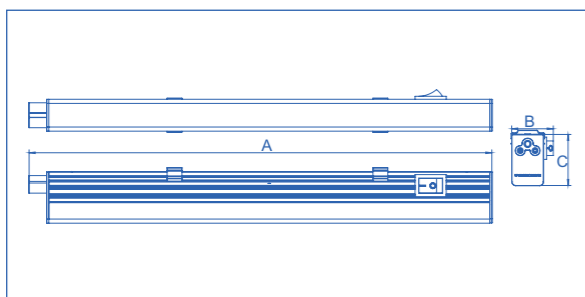

Length	A	B	C
0.3m	273	34.5	21.5
0.6m	573	34.5	21.5
0.9m	873	34.5	21.5
1.2m	1173	34.5	21.5

### 14W 120° Photometric

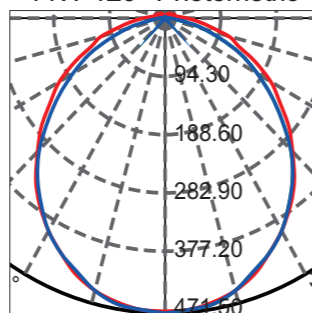

### 14W 120° Luminance

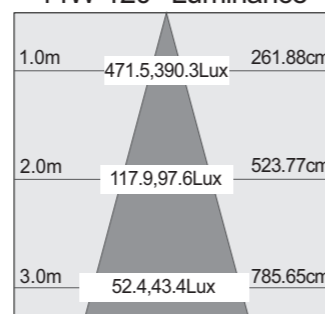

### TECHNICAL PARAMETERS

Series	Order number	Input voltage(V)	Wattage(W)	Lumen(Lm)	CCT(K)	CRI(Ra)
NS-T5-1J	T53004	AC 230	4	400	3000/4000/6500	> 80
NS-T5-2J	T56007	AC 230	7	700	3000/4000/6500	> 80
NS-T5-3J	T59010	AC 230	10	1000	3000/4000/6500	> 80
NS-T5-4J	T51214	AC 230	14	1400	3000/4000/6500	> 80

\*\* Lumen&Wattage: Type value with +/-10% tolerance.



## LED COB Downlight



### FEATURES

- Mounting ring: Die-casting aluminum;
- Reflector: Aluminum, satin anodized;
- Working temperature: -20°C to 40°C;
- Application: Hotel, hospital, office, school, supermarket, restaurant, government institute, showroom, ect.

### TECHNICAL PARAMETERS

Order number	Input vottage (V)	Wattage (W)	Dimension (mm)	Cut-out (mm)	Lumen (Lm)	CRI (Ra)	CCT(K)
NS-TD3-H10J	AC230	10	Ø115×H50	Ø90	600	> 80	3000/4000/6500
NS-TD5-H20J	AC230	20	Ø165×H60	Ø150	1300	> 80	3000/4000/6500
NS-TD8-H36J	AC230	36	Ø220×H60	Ø200	2340	> 80	3000/4000/6500



## LED Surface Mounted Downlight



### FEATURES

- Housing: Aluminum;
- Working temperature: -20°C to 40°C;
- Application: Hotel, hospital, office, school, supermarket, restaurant, government institution, showroom, etc.

### TECHNICAL PARAMETERS

Order number	Input vottage (V)	Wattage (W)	Dimension (mm)	Lumen (Lm)	CRI (Ra)	CCT(K)
NS-PLS-D12E6M	AC230	6	Ø120×H40	240	> 80	3000/4000/6500
NS-PLS-D17E12M	AC230	12	Ø174×H40	600	> 80	3000/4000/6500
NS-PLS-D22E18M	AC230	18	Ø225×H40	990	> 80	3000/4000/6500

\*\* Lumen&Wattage: Type value with +/-10% tolerance.





## LED Downlight



### FEATURES

- Low decay, high efficiency and high brightness SMD LED.
- Body in superior die-cast aluminium with polyester powder coating, non-discolouring;
- External independent regulatory power supply, high electrical efficiency, ensure long usage life.

### TECHNICAL PARAMETERS

Order number	Input voltage (V)	Wattage (W)	Dimension (mm)	Cut-out (mm)	Lumen (Lm)	CRI (Ra)	CCT(K)
NS-TD2.5-H5	AC230	5	Ø100×H45	Ø70	400	> 80	3000/4000/6500
NS-TD5-H15	AC230	15	Ø165×H55	Ø150	1350	> 80	3000/4000/6500
NS-TD6-H20	AC230	20	Ø190×H63	Ø175	1800	> 80	3000/4000/6500
NS-TD8-H20	AC230	20	Ø220×H70	Ø200	1800	> 80	3000/4000/6500
NS-TD8-H30	AC230	30	Ø220×H70	Ø200	2700	> 80	3000/4000/6500



## LED COB Downlight



### FEATURES

- Low decay, high efficiency and high brightness COB LED.
- Body in superior die-cast aluminium with polyester powder coating, non-discolouring;
- External independent regulatory power supply, high electrical efficiency, ensure long usage life.

### TECHNICAL PARAMETERS

Order number	Input voltage (V)	Wattage (W)	Dimension (mm)	Cut-out (mm)	Lumen (Lm)	CRI (Ra)	CCT(K)
NS-TD2.5-H5D	AC230	5	Ø100×H45	Ø70	400	> 80	3000/4000/6500
NS-TD3-H10D	AC230	10	Ø106×H50	Ø90	800	> 80	3000/4000/6500
NS-TD4-H15D	AC230	15	Ø143×H55	Ø125	1200	> 80	3000/4000/6500
NS-TD5-H20D	AC230	20	Ø165×H55	Ø150	1600	> 80	3000/4000/6500
NS-TD8-H30D	AC230	30	Ø230×H70	Ø200	2250	> 80	3000/4000/6500



## LED Slim Downlight



### FEATURES

- Housing: Aluminum;
- Working temperature: -20°C to 40°C;
- Application: Hotel, hospital, office, school, supermarket, restaurant, government institution, showroom, etc.

### TECHNICAL PARAMETERS

Order number	Input voltage (V)	Wattage (W)	Dimension (mm)	Cut-out (mm)	Lumen (Lm)	CRI (Ra)	CCT(K)
NS-TD2.5-P5H	AC230	5	Ø100×H30	Ø70	300	> 80	3000/4000/6500
NS-TD2.5-P12H	AC230	12	Ø170×H30	Ø150	780	> 80	3000/4000/6500
NS-TD2.5-P20H	AC230	20	Ø230×H30	Ø200	1400	> 80	3000/4000/6500

\*\* Lumen: Type value with +/-10% tolerance.

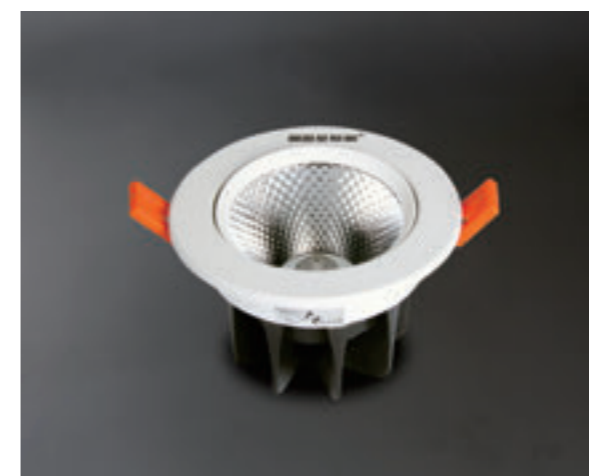

## LED Recessed Downlight



### FEATURES

- Housing: Aluminum;
- Working temperature: -20°C to 40°C;
- Application: Hotel, hospital, office, school, supermarket, restaurant, government institution, showroom, etc.

### TECHNICAL PARAMETERS

Order number	Input voltage (V)	Wattage (W)	Dimension (mm)	Cut-out (mm)	Lumen (Lm)	CRI (Ra)	Type	CCT(K)
NS-KD1-C7FA	AC230	7	Ø90×H60	Ø70	450	> 80	Moving Ring	3000/4000/6500
NS-KD1-C7FB	AC230	7	Ø90×H60	Ø70	450	> 80	Non-Moving Ring	3000/4000/6500

\*\* Lumen: Type value with +/-10% tolerance.



## LED SMD Downlight



### FEATURES

- Low decay, high efficiency and high brightness SMD LED;
- Delicate and unique embedded design;
- Low power consumption, long lifespan, reliable and safe;
- Built-in driver design.

### TECHNICAL PARAMETERS

Order number	Input voltage (V)	Wattage (W)	Dimension (mm)	Cut-out (mm)	Lumen (Lm)	CRI (Ra)	CCT(K)
NS-TD2.5-P4F	AC230	4	Ø88×H50	Ø70	280	> 80	3000/4000/6500
NS-TD3-P7F	AC230	7	Ø115×H55	Ø100	420	> 80	3000/4000/6500
NS-TD4-P10F	AC230	10	Ø146×H70	Ø125	700	> 80	3000/4000/6500
NS-TD6-P15F	AC230	15	Ø193×H92	Ø150	1050	> 80	3000/4000/6500
NS-TD8-P20F	AC230	20	Ø220×H100	Ø200	1500	> 80	3000/4000/6500



## LED COB Downlight



### FEATURES

- Low decay, high efficiency and high brightness COB LED;
- Delicate and unique embedded design;
- Low power consumption, long lifespan, reliable and safe.

### TECHNICAL PARAMETERS

Order number	Input voltage (V)	Wattage (W)	Dimension (mm)	Cut-out (mm)	Lumen (Lm)	CRI (Ra)	CCT(K)
NS-KD1-C5F	AC230	5	Ø90×H50	Ø70	350	> 80	3000/4000/6500
NS-KD1-C12F	AC230	12	Ø110×H75	Ø100	900	> 80	3000/4000/6500
NS-KD1-C20F	AC230	20	Ø133×H92	Ø125	1500	> 80	3000/4000/6500
NS-KD1-C30F	AC230	30	Ø160×H100	Ø150	2400	> 80	3000/4000/6500

\*\* Lumen&Wattage: Type value with +/-10% tolerance.



# Industrial Lighting

AC230V

120°

IP65



## LED Batten IP65

(On/Off Version)



### FEATURES

- Design-oriented, plastic opal diffuser
- Impact protection: IK08
- Replacement for fluorescent lamp
- Microwave-sensor/DALI dimming/emergency
- IP65 Fixture
- Application: garage, basement, corridor

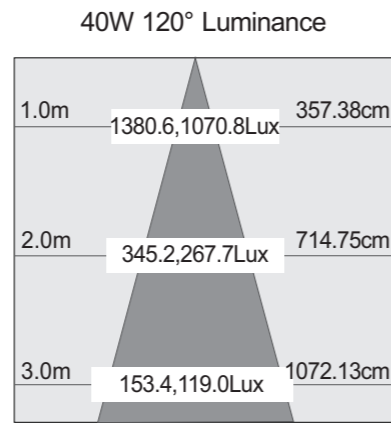
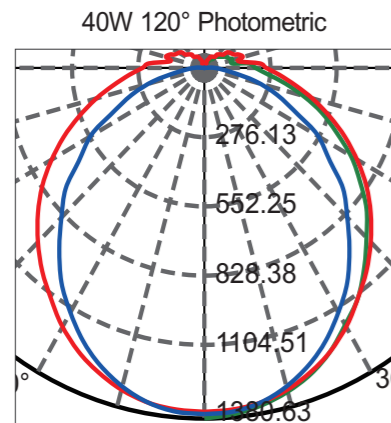

### DIMENSIONS

UNIT:mm

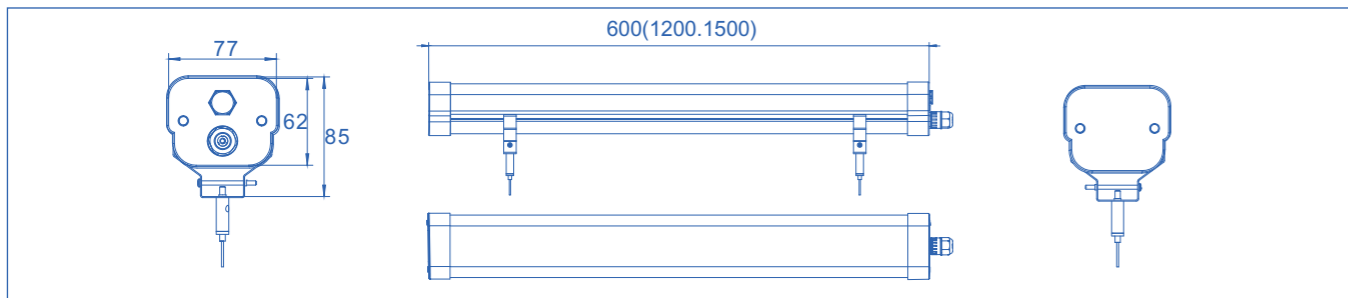

### TECHNICAL PARAMETERS

Series	Order number	Input voltage(V)	Wattage(W)	Dimension (mm)	Lumen(Lm)	CCT(K)
NS-TPL-2A30	TPL0630	AC 230	30	600×77×62	3000	3000/4000/6500
NS-TPL-4A40	TPL1240	AC 230	40	1200×77×62	4000	3000/4000/6500
NS-TPL-5A60	TPL1560	AC 230	60	1500×77×62	6000	3000/4000/6500

\*\* Lumen&Wattage: Type value with +/-10% tolerance.



## LED Batten IP65

(Multi-Connection Version)



### FEATURES

- Design-oriented, plastic opal diffuser
- Impact protection: IK08
- Replacement for fluorescent lamp
- Microwave-sensor/DALI dimming/emergency
- IP65 Fixture
- Application: garage, basement, corridor

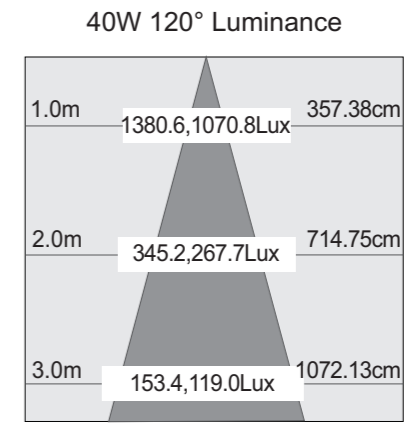
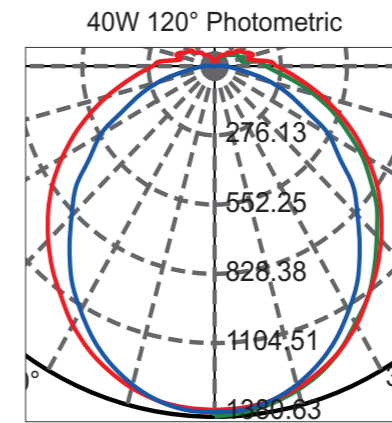

### DIMENSIONS

UNIT:mm

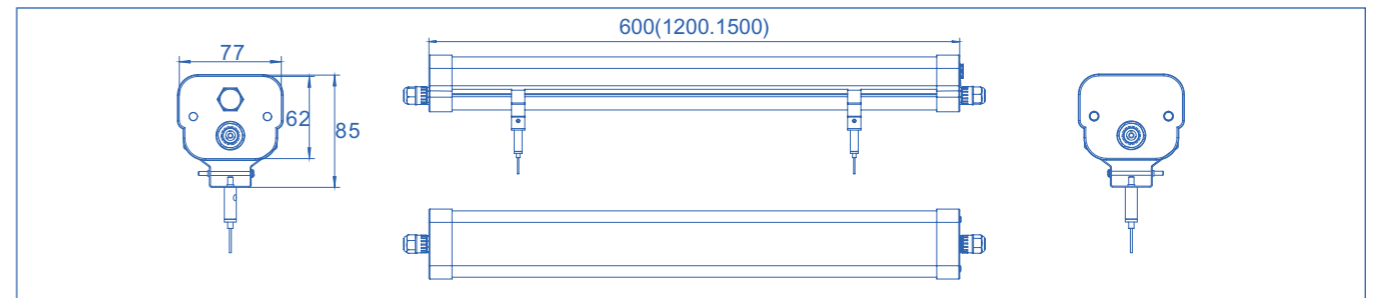

### TECHNICAL PARAMETERS

Series	Order number	Input voltage(V)	Wattage(W)	Dimension (mm)	Lumen(Lm)	CCT(K)	Max Multi-connect QTY
NS-TPL-2A30	TPL0630M	AC 230	30	600×77×62	3000	3000/4000/6500	15
NS-TPL-4A40	TPL1240M	AC 230	40	1200×77×62	4000	3000/4000/6500	10
NS-TPL-5A60	TPL1560M	AC 230	60	1500×77×62	6000	3000/4000/6500	7

\*\* Lumen&Wattage: Type value with +/-10% tolerance.





## SMD Flood Light



### FEATURES

- Aluminum fitting;
- Aluminum reflector;
- Glass cover, IP65, SMD;
- Working temperature: -20°C to 40°C;
- Your optimal outdoor parter Outdoor flood light is an amazing design, with low cost and safety;
- This product can replace metal halide flood light.

### TECHNICAL PARAMETERS

Series	Input voltage(V)	Wattage(W)	Dimension (mm)	Lumen(Lm)	CCT(K)	Beam Angle(°)
NS-TGD-A10B	AC 230	10	127×118×34	800	3000/4000/6500	120
NS-TGD-A50B	AC 230	50	285×272×58	4000	3000/4000/6500	120
NS-TGD-A100B	AC 230	100	290×290×75	8000	3000/4000/6500	120



## COB Flood Light



### FEATURES

- Aluminum fitting;
- Aluminum reflector;
- Glass cover, IP65, COB;
- Working temperature: -20°C to 40°C;
- Your optimal outdoor parter Outdoor flood light is an amazing design, with low cost and safety;
- This product can replace metal halide flood light.

### TECHNICAL PARAMETERS

Series	Input voltage(V)	Wattage(W)	Dimension (mm)	Lumen(Lm)	CCT(K)	Beam Angle(°)
NS-TGD-A150	AC 230	150	425x325x200	11250	3000/4000/6500	110
NS-TGD-A200	AC 230	200	603x325x250	15000	3000/4000/6500	110

\*\* Lumen&Wattage: Type value with +/-10% tolerance.



## UFO High Bay Light



### FEATURES

- Aluminum fitting, Aluminum reflector;
- Working temperature: -20°C to 40°C;
- Application: Various sport venues, industrial workshop, warehouses, airport, railway stations, gas stations, playground, exhibition halls, supermarkets and other indoor public places;
- This device can replace Metal Halide high bay.

### TECHNICAL PARAMETERS

Series	Input voltage(V)	Wattage(W)	Dimension (mm)	Lumen(Lm)	CCT(K)	Beam Angle(°)
NS-GKD-C150A	AC 230	150	Ø240x187	15000	3000/4000/6500	90
NS-GKD-C200A	AC 230	200	Ø280x194	20000	3000/4000/6500	90



## LED Street Light



### FEATURES

- Housing: Aluminum;
- Working temperature: -20°C to 40°C;
- Application: Various sport venues, playground, streets, etc;
- The product can be used in road and streets, as it distributes the light in an organized way, This product can give a big glow.

### TECHNICAL PARAMETERS

Series	Input voltage(V)	Wattage(W)	Dimension (mm)	Lumen(Lm)	CCT(K)	Beam Angle(°)
NS-LD-A120C	AC 230	120	632x215x92	13000	3000/4000/6500	120



# Decorative Lighting

DC24V/  
AC230V IP20/IP65/IP67



## LED Strip IP20 NS-A3528 Series

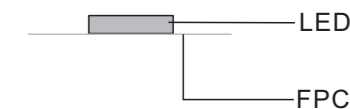

### FEATURES

- High Brightness SMD2835
- Strips can be cut on the cutting mark and reconnect
- Standard PCB color: White
- Led Option: Mac Adam 3 or 5 step
- CRI 80/90
- 3M Adhesive Backing

### TECHNICAL PARAMETERS

Order number	LED Qty (pcs/m)	Wattage (W/m)	LUMEN (Lm/m*Ra80)	Length (Meter/Reel)	Strip width (mm)	Maximum connection length (M)	CCT ( K )	CRI (Ra)
NS-A3528RW60-24	60	5	480	10	8	10	2700	>80/90
NS-A3528WW60-24	60	5	500	10	8	10	3000	>80/90
NS-A3528NW60-24	60	5	520	10	8	10	4000	>80/90
NS-A3528CW60-24	60	5	520	10	8	10	6500	>80/90
NS-A3528RW60-24H	60	12	980	10	10	8	2700	>80/90
NS-A3528WW60-24H	60	12	1020	10	10	8	3000	>80/90
NS-A3528NW60-24H	60	12	1100	10	10	8	4000	>80/90
NS-A3528CW60-24H	60	12	1100	10	10	8	6500	>80/90
NS-A3528RW120-24	120	12	1050	10	8	6	2700	>80/90
NS-A3528WW120-24	120	12	1080	10	8	6	3000	>80/90
NS-A3528NW120-24	120	12	1200	10	8	6	4000	>80/90
NS-A3528CW120-24	120	12	1200	10	8	6	6500	>80/90
NS-A3528RW120-24H	120	24	1960	10	10	4	2700	>80/90
NS-A3528WW120-24H	120	24	2040	10	10	4	3000	>80/90
NS-A3528NW120-24H	120	24	2160	10	10	4	4000	>80/90
NS-A3528CW120-24H	120	24	2160	10	10	4	6500	>80/90
NS-A3528RW240-24	240	20	1920	10	12	5	2700	>80/90
NS-A3528WW240-24	240	20	2000	10	12	5	3000	>80/90
NS-A3528NW240-24	240	20	2050	10	12	5	4000	>80/90
NS-A3528CW240-24	240	20	2050	10	12	5	6500	>80/90

\*\* Lumen: Type value with +/-10% tolerance.



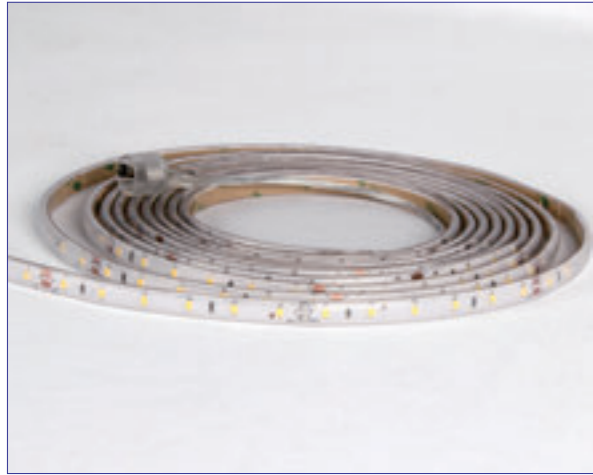

## LED Strip

### IP65 NS-D3528 Series

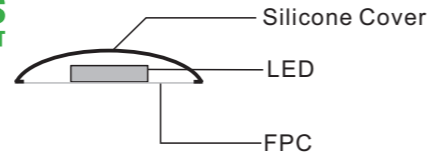

#### FEATURES

- High brightness SMD2835
- Strips can be cut on the cutting mark and reconnect
- Standard PCB color: White
- Led option: Mac Adam 3 or 5 step
- CRI 80/90
- 3M adhesive backing

#### TECHNICAL PARAMETERS

Order number	LED Qty (pcs/m)	Wattage (W/m)	LUMEN (Lm/m*Ra80)	Length (Meter/Reel)	Strip Width (mm)	Maximum connection length (M)	CCT ( K )	CRI (Ra)
NS-D3528RW60-24	60	5	460	5	9	10	2700	>80/90
NS-D3528WW60-24	60	5	480	5	9	10	3000	>80/90
NS-D3528NW60-24	60	5	500	5	9	10	4000	>80/90
NS-D3528CW60-24	60	5	500	5	9	10	6500	>80/90
NS-D3528RW60-24H	60	12	950	5	11	8	2700	>80/90
NS-D3528WW60-24H	60	12	975	5	11	8	3000	>80/90
NS-D3528NW60-24H	60	12	1050	5	11	8	4000	>80/90
NS-D3528CW60-24H	60	12	1050	5	11	8	6500	>80/90
NS-D3528RW120-24	120	12	1000	5	9	6	2700	>80/90
NS-D3528WW120-24	120	12	1050	5	9	6	3000	>80/90
NS-D3528NW120-24	120	12	1100	5	9	6	4000	>80/90
NS-D3528CW120-24	120	12	1100	5	9	6	6500	>80/90
NS-D3528RW120-24H	120	24	1900	5	11	4	2700	>80/90
NS-D3528WW120-24H	120	24	2000	5	11	4	3000	>80/90
NS-D3528NW120-24H	120	24	2100	5	11	4	4000	>80/90
NS-D3528CW120-24H	120	24	2100	5	11	4	6500	>80/90
NS-D3528RW240-24	240	20	1860	5	13	5	2700	>80/90
NS-D3528WW240-24	240	20	1920	5	13	5	3000	>80/90
NS-D3528NW240-24	240	20	2000	5	13	5	4000	>80/90
NS-D3528CW240-24	240	20	2000	5	13	5	6500	>80/90

\*\* Lumen: Type value with +/-10% tolerance.



## LED Strip

### IP65

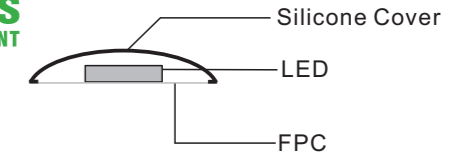

#### FEATURES

- High luminous flux;
- Anti-vulcanization;
- Waterproof with PVC casing, Water Proof classes: IP65;
- This product is perfect for tight and curved places;
- It takes the shape of the place which you want to light like racks lighting in stores.

#### TECHNICAL PARAMETERS

Order number	LED Type	LED Qty (pcs/m)	Wattage (W/m)	Length (Meter/Reel)	Strip Width (mm)	Maximum connection length (M)	CCT ( K )	CRI (Ra)
2835-180-220V-XW	2835	180	8	5	12	10	3000/4000/6000	>80
5050-60-220V-RGB	5050	60	10	5	10	10	RGB	>80



## Accessories for Non-waterproof/ IP20 LED Strip

### LED Strip In Line Dimmer

- 0-100% Dimming
- Can only be used in DC12/24V
- For indoor use only



### RGB Controller

- Must be used with RGB LED strips
- With remote controller
- Adjusts speed and brightness
- Connects between power supply and strips



### Power Feed

- Connects strips to power supply



### RGB Power Supply Leads

- Connects strips to power supply
- Power supply



## Single Color Connectors

### Inline Splice

- Connects 2 sections of the strips together



## RGB Connectors

### Inline Splice

- Connects 2 sections of the strips together



### Interconnect Cable

- Connects 2 sections of the strips together



### Interconnect Cable

- Connects 2 sections of the strips together



### 3-Way Connector

- Connects 3 sections of the strips together
- One input, two outputs
- Ideal for making "T" & "Y" connections



### RGB 3-Way Connector

- Connects 3 sections of the strips together
- One input, two outputs
- Ideal for making "T" & "Y" connections



### 4-Way Connector

- Connects 4 sections of the strips together
- One input, three outputs



### RGB 4-Way Connector

- Connects 4 sections of the strips together
- One input, three outputs



## Accessories for Waterproof/ IP65&IP67 LED Strip

### Power Feed

- Connects strips to power supply



### RGB Power Supply Leads

- Connects strips to power supply



## Single Color Connectors

### Interconnect Cable

- Connects 2 sections of the strips together



## RGB Connectors

### Interconnect Cable

- Connects 2 sections of the strips together



### 3-Way Connector

- Connects 3 sections of the strips together
- One input, two outputs
- Ideal for making "T" & "Y" connections



### RGB 3-Way Connector

- Connects 3 sections of the strips together
- One input, two outputs
- Ideal for making "T" & "Y" connections



### 4-Way Connector

- Connects 4 sections of the strips together
- One input, three outputs



### RGB 4-Way Connector

- Connects 4 sections of the strips together
- One input, three outputs



### End Cap

- Terminal for the strips



### Power Supply

- Outdoor Power Supply



### Silicone

- Silicone glue for the end cap



### Clips

- Fix the strips on the surface



